

MS1000L - Datasheet

Single axis analog accelerometer

The MS1000L product is a cost-effective MEMS capacitive accelerometer based on a bulk micro-machined silicon element specifically designed for highest stability. The product is low power, fully calibrated, robust up to 6'000 g and extremely stable.

The internal electronic circuit integrates a signal conditioning with a differential analog $\pm 2.7V$ output, a built in self test and a temperature sensor available for improving accuracy by thermal compensation. The sensor is fully self-contained and packaged in a 20-pin LCC ceramic housing, thus insuring a full hermeticity for harsh environments.



Key features

- **Non-linearity: 0.3% FS**
- **Noise in band: 7 $\mu g/\sqrt{Hz}$ (2g range)**
- **Excellent bias repeatability**
- **Small hermetic LCC20 ceramic package**
- **Reliable in harsh environment**
- **Single 3.3V power supply**

Key Parameters, typical values	MS1002L	MS1005L	MS1010L	MS1030L	MS1050L	MS1100L	Unit
Full-Scale acceleration	± 2	± 5	± 10	± 30	± 50	± 100	g
Bias temp. coefficient	± 0.1	± 0.25	± 0.5	± 1.5	± 2.5	± 5	mg/°C
Noise (in band)	7	17	34	102	170	339	$\mu g/\sqrt{Hz}$
In-run bias stability	3	7.5	15	45	75	150	μg
Scale Factor Sensitivity	1350	540	270	90	54	27	mV/g
Scale factor temp. coefficient	120	120	120	120	120	120	ppm/°C
Non-Linearity (IEEE Norm)	0.3	0.3	0.3	0.3	0.3	0.3	%
Axis misalignment	3	3	3	3	3	3	mrad
Power consumption	10	10	10	10	10	10	mW
Operational temperature	-40 to +125	-40 to +125	-40 to +125	-40 to +125	-40 to +125	-40 to +125	°C
Size	9 x 9	9 x 9	9 x 9	9 x 9	9 x 9	9 x 9	mm ²
Resonant frequency	1.4	2.9	3.7	6.3	11	15	kHz

Featured Applications (non-exhaustive):

Aerospace & Defense:

Inertial Measurement Units (IMUs)
 avionics (fix wings and rotary wings): FCS, autopilot,
 attitude systems (AHRS, stand by),
 weapon launch systems – platform stabilization
 GPS aided guidance & navigation UAV systems
 short range guidance, robotics

Naval & Land:

North finding, antenna, sonar orientation
 ROV guidance, weapon launch systems,
 ship navigation and control
 mobile mapping
 train positioning (GPS dead reckoning)
 MWD – drilling guidance

MS1010L PARAMETERS

All values are specified at ambient temperature (20°C) and at 3.3 V supply voltage V_{DD} , unless otherwise stated. Acceleration values are defined for differential signal (OUTP-OUTN).

Parameter	Comments	Min	Typ.	Max	Unit
Accelerometer					
Full scale		±10			g
Non-Linearity	IEEE Norm, % of full scale		0.3	1.0	%
Frequency response	-3dB	100			Hz
Resonant frequency			3.7		kHz
Noise	in band		34		$\mu\text{g}/\sqrt{\text{Hz}}$
Resolution	@ 1Hz		34		$\mu\text{g rms}$
Startup time	Sensor operational, delay once POR triggered		40		μs
Bias (K0)					
Nominal	Calibration accuracy	-34		34	mg
Temperature coefficient	See glossary	-2	±0.5	2	$\text{mg}/^\circ\text{C}$
Long term bias repeatability at 20°C	@1'000g - See glossary		1.5		mg
	@6'000g - See glossary		7.5		mg
In-run bias stability	Based on Allan Variance characterization (@ 10s)		15		μg
TurnON - TurnON	See glossary		75		μg
Scale factor (K1)					
Nominal	Calibration accuracy	266	270	274	mV/g
Temperature coefficient	See glossary	20	120	220	$\text{ppm}/^\circ\text{C}$
Long term scale factor repeatability at 20°C	See glossary		300		ppm
Axis misalignment	See glossary K_p, K_h		3		mrad
Self-test					
Frequency	Square wave output		25		Hz
Duty cycle			50		%
Amplitude	Peak to peak		1		g
Input threshold voltage	active high	80			% V_{DD}
Temperature sensor					
Output voltage @20°C		1.20	1.23	1.26	V
Sensitivity			-4		$\text{mV}/^\circ\text{C}$
Output current load				10	μA
Output capacitive load				10	pF
Reset					
Input threshold voltage	active low			20	% V_{DD}
Power requirements					
Supply voltage (V_{DD})		3.2	3.3	3.4	V
Supply current (I_{DD})			2.3	4	mA
Accelerometer outputs					
Output voltages	OutP, OutN over full scale	0.14		3.16	V
Differential output	Over full scale		±2.7		V
Resistive load		1000			k Ω
Capacitive load				100	pF
General					
Reliability assessment	Based on FIDES 2009 Edition A Sept. 2010, available on request.				

Table 1: MS1010L Specifications

MS1030L PARAMETERS

All values are specified at ambient temperature (20°C) and at 3.3 V supply voltage V_{DD} , unless otherwise stated. Acceleration values are defined for differential signal (OUTP-OUTN).

Parameter	Comments	Min	Typ.	Max	Unit
Accelerometer					
Full scale		±30			g
Non-Linearity	IEEE Norm, % of full scale		0.3	1.0	%
Frequency response	-3dB	100			Hz
Resonant frequency			6.3		kHz
Noise	in band		102		$\mu\text{g}/\sqrt{\text{Hz}}$
Resolution	@ 1Hz		102		$\mu\text{g rms}$
Startup time	Sensor operational, delay once POR triggered		40		μs
Bias (K0)					
Nominal	Calibration accuracy	-100		100	mg
Temperature coefficient	See glossary	-6	±1.5	6	$\text{mg}/^\circ\text{C}$
Long term bias repeatability at 20°C	@1'000g - See glossary		4.5		mg
	@6'000g - See glossary		22.5		mg
In-run bias stability	Based on Allan Variance characterization (@ 10s)		45		μg
TurnON - TurnON	See glossary		0.22		mg
Scale factor (K1)					
Nominal	Calibration accuracy	88.5	90	91.5	mV/g
Temperature coefficient	See glossary	20	120	220	$\text{ppm}/^\circ\text{C}$
Long term scale factor repeatability at 20°C	See glossary		300		ppm
Axis misalignment	See glossary K_p, K_h		3		mrad
Self-test					
Frequency	Square wave output		25		Hz
Duty cycle			50		%
Amplitude	Peak to peak		1		g
Input threshold voltage	active high	80			% V_{DD}
Temperature sensor					
Output voltage @20°C		1.20	1.23	1.26	V
Sensitivity			-4		$\text{mV}/^\circ\text{C}$
Output current load				10	μA
Output capacitive load				10	pF
Reset					
Input threshold voltage	active low			20	% V_{DD}
Power requirements					
Supply voltage (V_{DD})		3.2	3.3	3.4	V
Supply current (I_{DD})			2.3	4	mA
Accelerometer outputs					
Output voltages	OutP, OutN over full scale	0.14		3.16	V
Differential output	Over full scale		±2.7		V
Resistive load		1000			k Ω
Capacitive load				100	pF
General					
Reliability assessment	Based on FIDES 2009 Edition A Sept. 2010, available on request.				

Table 2: MS1030L Specifications

Absolute maximum ratings

Absolute maximum ratings are stress ratings. Stress in excess of the environmental specifications in the datasheet can cause permanent damage to the device. Exposure to the maximum ratings for an extended period of time may degrade the performance and affect reliability.

Parameters	Comments	Min.	Max.	Unit
Supply voltage Vdd		-0.3	+3.9	V
Voltage at any pin		-0.3	Vdd+0.3	V
Temperature	Operational	-40	125	°C
	Storage	-55	125	°C
Vibration	Random / 20 – 2'000 Hz		20	g rms
Shock	0.15 ms, half sine, single shock, not repetitive, in one direction		6'000	g
ESD stress	HBM model	-1	1	kV

Table 3: Absolute maximum ratings

Typical performances characteristics

MS1010L: Typical initial performances on multiple sensor at 3.3 VDC supply voltage (V_{DD}) and ambient temperature for all graphs, unless otherwise stated (multiple sensor: multiple color line , min/max: red line , typical value: green line).

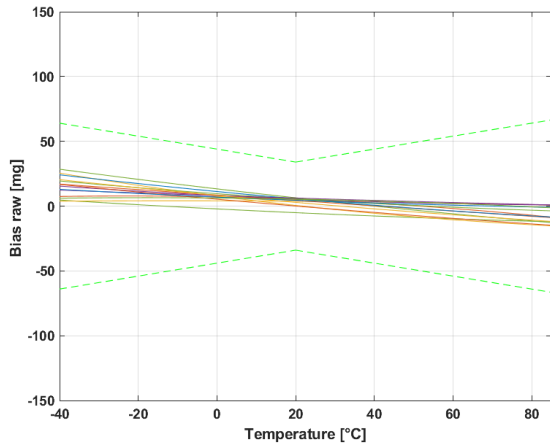

Figure 1: Raw bias

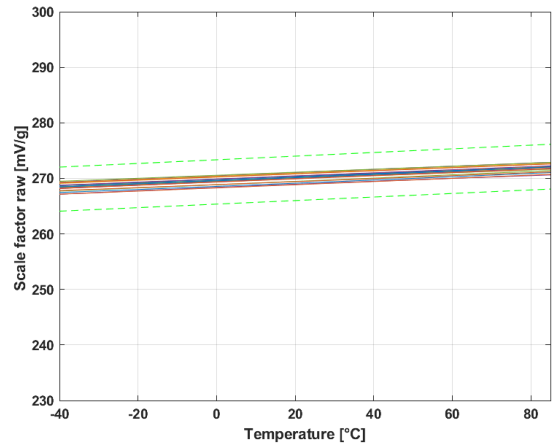

Figure 2: Raw scale factor

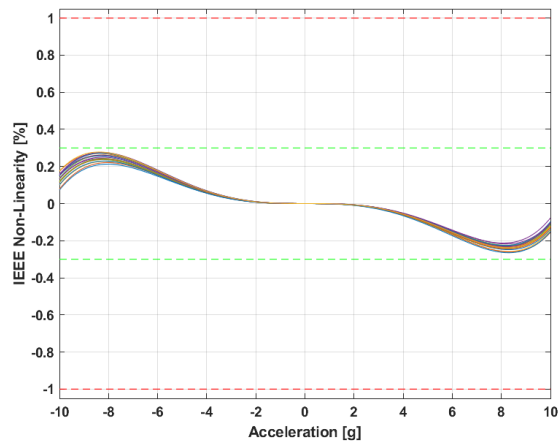

Figure 3 : Non-linearity IEEE

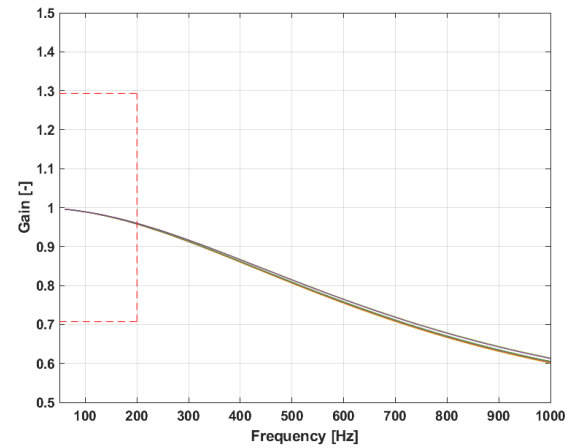

Figure 4 : Frequency response

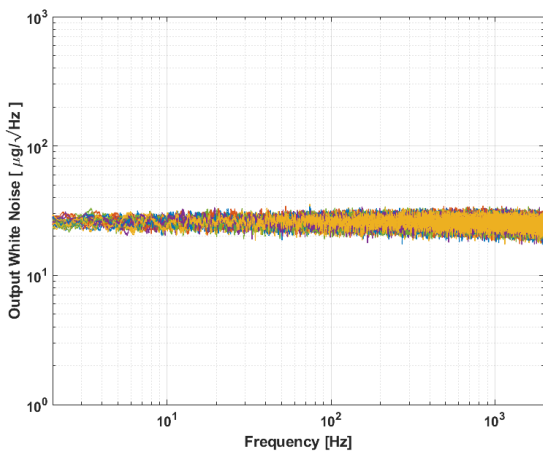

Figure 5: Typical white noise

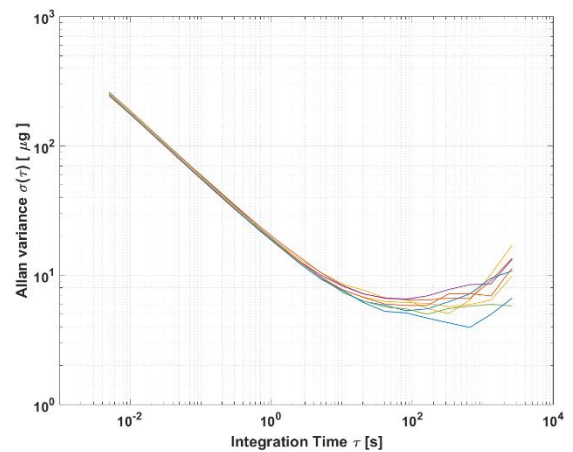

Figure 6: Allan Variance

MS1030L: Typical initial performances on multiple sensor at 3.3 VDC supply voltage (V_{DD}) and ambient temperature for all graphs, unless otherwise stated (multiple sensor: multiple color line , min/max: red line , typical value: green line).

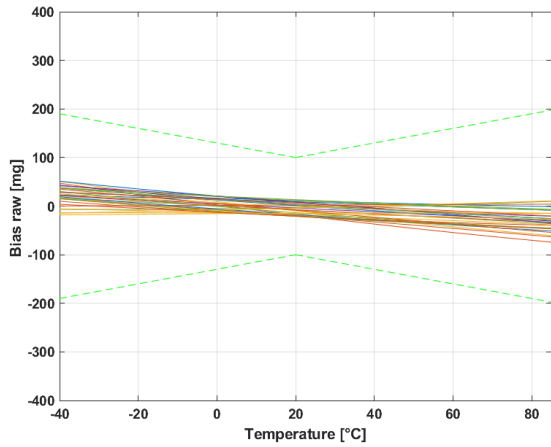

Figure 7: Raw Bias over temperature

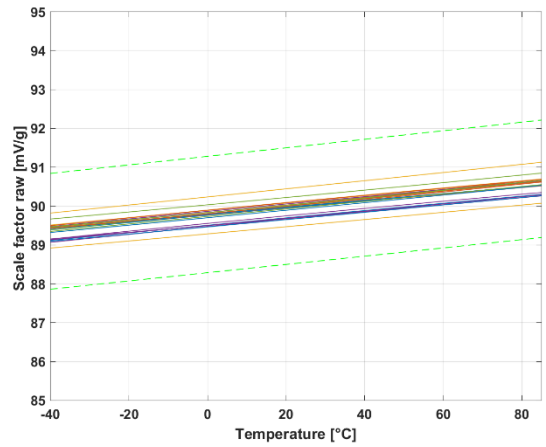

Figure 8: Raw Scale Factor over temperature

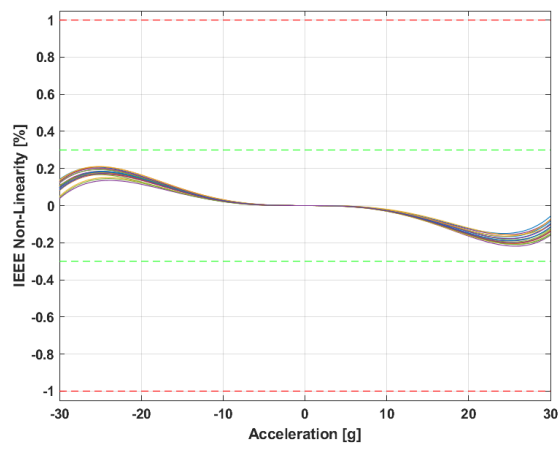

Figure 9 : Non-linearity IEEE

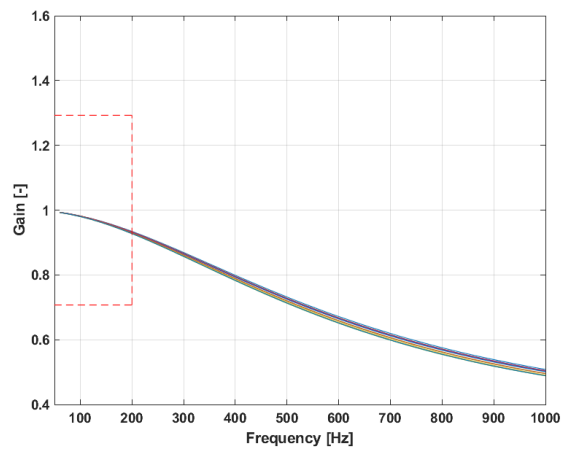

Figure 10 : Frequency response

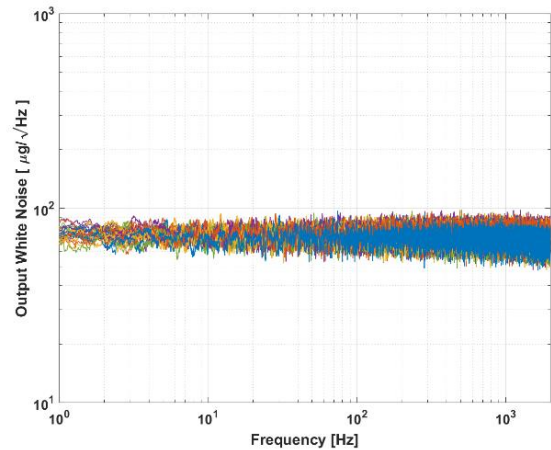

Figure 11: Typical white noise

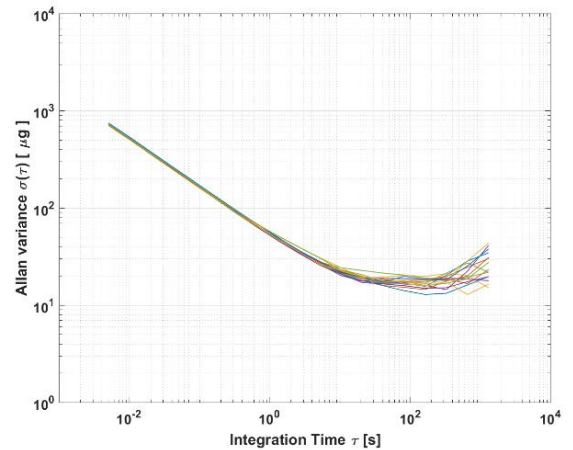

Figure 12: Allan Variance

Pinout description

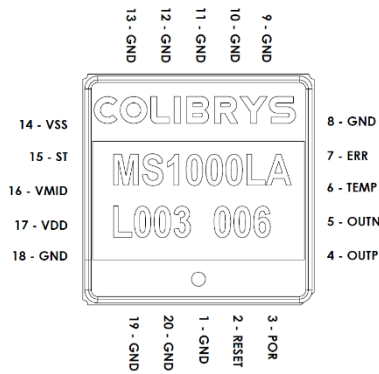

Figure 13 : Pinout top view

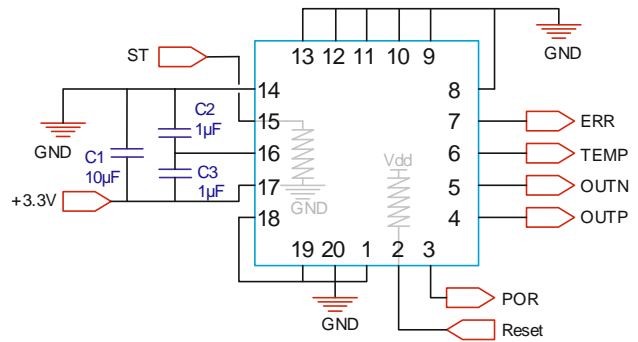

Figure 14 : Proximity circuit & internal pull-up/down

The device pin layout is given above and a description of each pin given in the table below capacitors C1 (10 µF), C2 (1 µF) and C3 (1 µF) are shown in above diagram Figure 14 and must be placed as close as possible to the MS1000L package and are used as decoupling capacitors and for a proper sensor startup.

Pin Nb.	Pin name	Type	Description
2	RESET	LI, PU	System reset signal, active low
3	POR	LO	Power On Reset
4	OUTP	AO	Differential output positive signal
5	OUTN	AO	Differential output negative signal
6	TEMP	AO	Temperature analogue output
7	ERR	LO	Error signal (flag)
14	V _{SS} (0 V)	PWR	Connect to ground plane
15	ST	LI, PD	Self-test activation, active high
16	V _{MID}	AO	Internal electronic circuit reference voltage. For decoupling capacitors only
17	V _{DD} (3.3 V)	PWR	Analogue power supply
1,8,9,10,11, 12,13,18,19,20	GND	GND	Must be connected to ground plane (GND)

*PWR, power / AO, analog output / AI, analog input /
LO, logical output / LI, logical input / PD, internal pull down / PU, internal pull up*

Table 4: MS1000L pinout description

Electrical Functions description

Introduction

MS1000L has electrical logic function embedded such as Power-On-Reset, External reset, Built in Self-test and Overload error detection. All those functions are described below.

POR (Power-On-Reset) function

The POR block continuously monitors the power supply during startup as well as normal operation. It ensures a proper startup of the sensor and acts as a brownout protection in case of a drop in supply voltage.

During sensor power on, the POR signal stays low until the supply voltage reaches the POR threshold voltage (V_{TH}) and begins the startup sequence. In case of a supply voltage drop, the POR signal will stay low until the supply voltage exceeds V_{TH} and is followed by a new startup sequence. The ERR signal is high (equal to V_{DD}) until the startup sequence is complete.

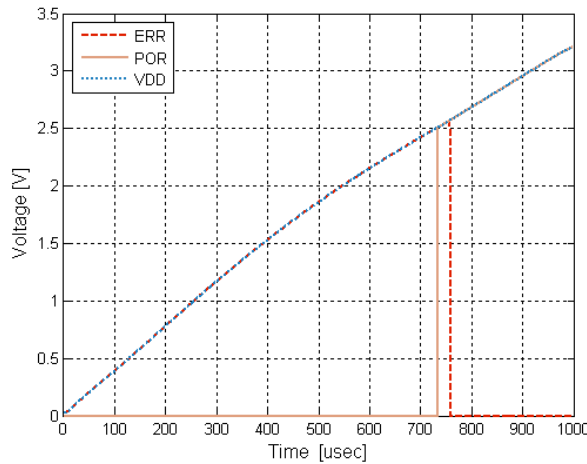

Figure 15 : Typical sensor power sequence using the recommended circuit

External Reset

An external reset can be activated by the user through the RESET input pin. During a reset phase, the accelerometer outputs (OUTP & OUTN) are forced to $V_{DD} / 2$ and the error signal (ERR) is activated (high), see figure below.

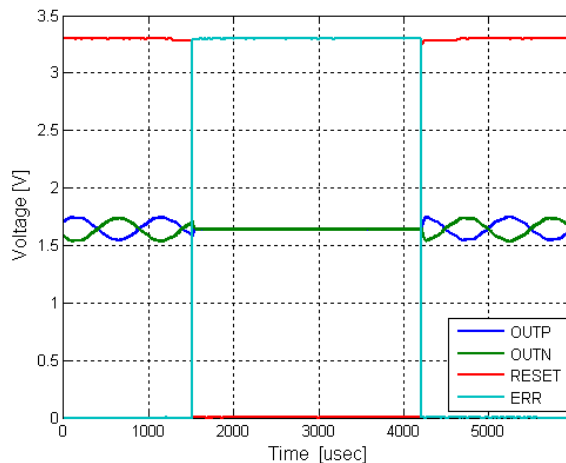

Figure 16 : Typical sensor reset sequence with external reset

Built-in Self-Test function

The built-in Self-Test mode generates a square wave signal on the device outputs (OUTP & OUTN) and can be used for device failure detection (see figure below).

When activated, it induces an alternating electrostatic force on the mechanical sensing element and emulates an input acceleration at a defined frequency. This electrostatic force is in addition to any inertial acceleration acting on the sensor during self-test; therefore it is recommended to use the self-test function under quiescent conditions.

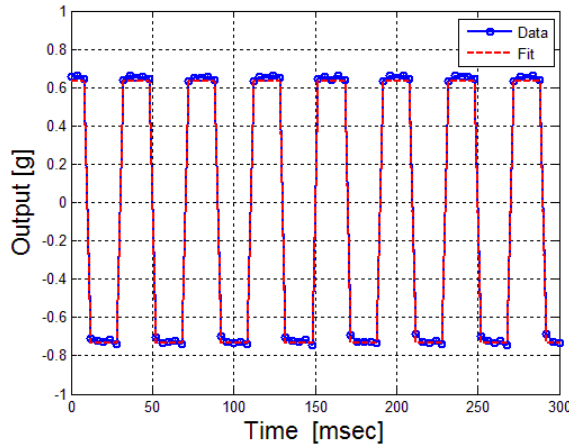

Figure 17 : Built-in Self-Test signal on the differential acceleration output (frequency: 24 Hz / amplitude 1.3 g)

Overload and error function

The device continuously monitors the validity of the accelerometer output signals. If an error occurs, the ERR pin goes high and informs the user that the output signals are not valid. An error can be raised in the following cases:

- Out-of-tolerance power supply voltage (POR low), such as during power on
- During external reset phase (user activation of the reset)
- Under high acceleration overload (e.g. high shock)

Upon a high-amplitude shock, the internal overload circuit resets the electronics and initiates a new startup of the readout electronics. This sequence is repeated until the acceleration input signal returns to normal operation range. This behavior is illustrated on the figure below with a large shock of amplitude 500 g: the overload protection is active during the shock and the sensor is fully operational once the acceleration is within the operating range

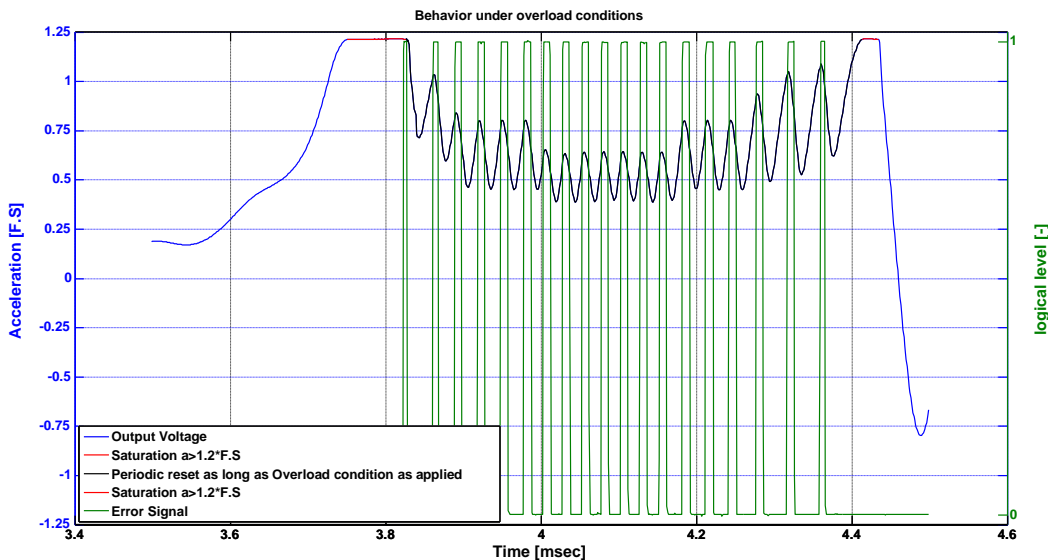

Figure 18 : Overload Behavior

Dimensions and package specifications

The outline of the LCC20 ceramic package and the Center of Gravity (CG) is illustrated below.

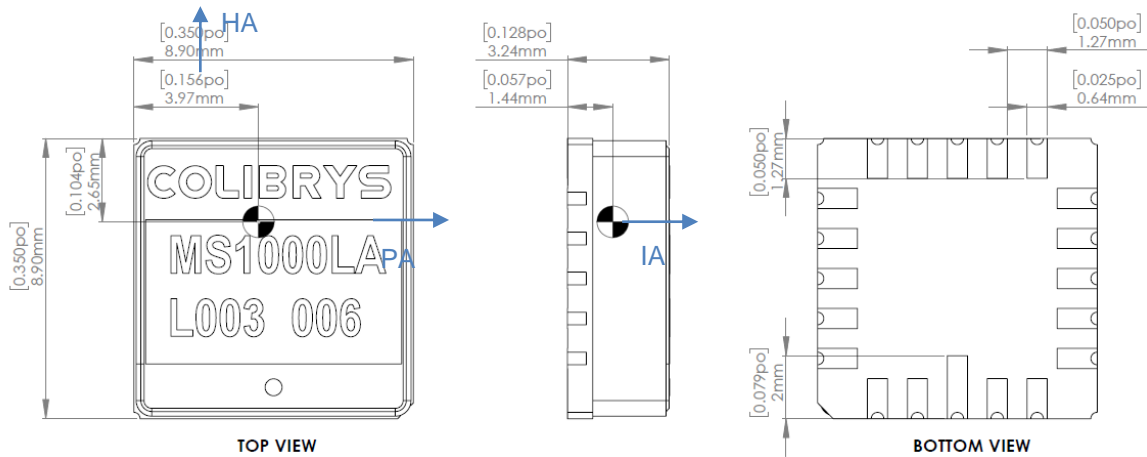

Figure 19 : Package mechanical dimension. Units are mm [inch]

Parameter	Comments	Min	Typ	Max	Unit
Lead finishing	Au plating	0.5		1.5	µm
	Ni plating	1.27	4	8.89	µm
	W (tungsten)	10		15	µm
Hermeticity	According to MIL-STD-883-G			5·10 ⁻⁸	atm·cm ³ /s
Weight				1.5	grams
Size	X		8.9	9.2	mm
	Y		8.9	9.2	mm
	Z		3.23	3.5	mm
Packaging	RoHS compliant part. Nonmagnetic, LCC20 pin housing.				
Proximity effect	The sensor is sensitive to external parasitic capacitance. Moving metallic objects with large mass or parasitic effect in close proximity of the accelerometer (mm range) must be avoided to ensure best product performances. A ground plane below the accelerometer is recommended as a shielding.				
Reference plane for axis alignment	LCC must be tightly fixed to the circuit board, using the bottom of the housing as the reference plane for axis alignment. Using the lid as reference plane or for assembly may affect specifications and product reliability (i.e. axis alignment and/or lid soldering integrity)				

Table 5: Package specifications

Recommended circuit

In order to obtain the best device performance, particular attention must be paid to the proximity analog electronics. A proposed circuit that includes a reference voltage, the sensor decoupling capacitors and output buffers is described below.

Optimal acceleration measurements are obtained using the differential output (OUTP – OUTN). If a single-ended acceleration signal is required, it must be generated from the differential acceleration output in order to remove the common mode noise.

Block Diagram & Schematic

The main blocks that require particular attention are the power supply management, the accelerometer sensor electronic and the output buffer. The following schematic shows an example of MS1000L implementation.

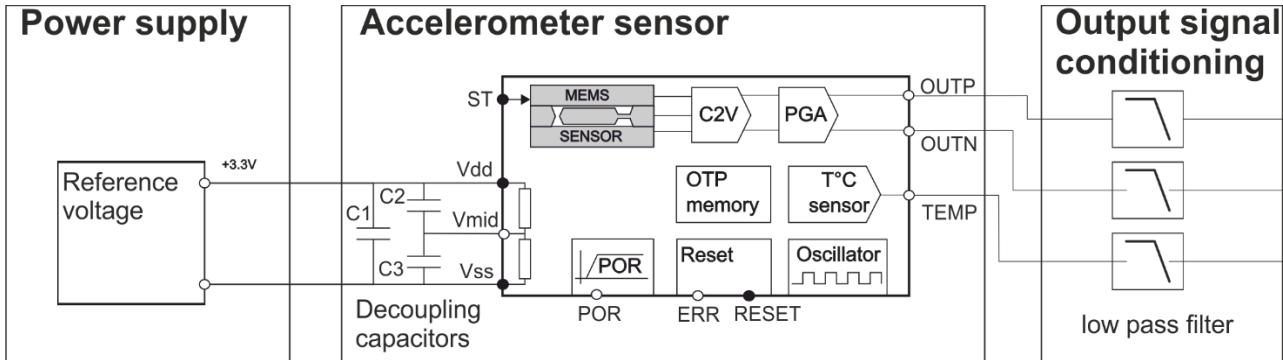

Figure 20 : Recommended Block diagram

Power Supply

The accelerometer output is ratiometric to the power supply voltage and its performance will directly impact the accelerometer bias, scale factor, noise or thermal performance. Therefore, a low-noise, high-stability and low-thermal drift power supply is recommended. Key performance should be:

- Output noise < $1\mu\text{V}/\sqrt{\text{Hz}}$
- Output temperature coefficient < $10\text{ppm}/^\circ\text{C}$

The power supply can be used as an output signal in order to compensate any variation on the power supply voltage that will impact the accelerometer signal (ratiometric output).

The electronic circuit within the accelerometer is based on a switched-capacitor architecture clocked at 200 kHz. High-frequency noise or spikes on the power supply will affect the outputs and induce a signal within the device bandwidth.

Accelerometer sensor

The sensor block is composed of the MS1000L accelerometer and the 3 decoupling capacitors: C1 [$10\mu\text{F}$], C2 [$1\mu\text{F}$] and C3 [$1\mu\text{F}$]. These capacitors are mandatory for the proper operation and full performance of the accelerometer. We recommend placing them as close as possible to the MS1000L package on the printed circuit board.

Output signal conditioning

The output signal must be correctly filtered and buffered before data acquisition. We recommend using an ultra-low offset, drift and bias current operational amplifier that match the MS1000L output impedance and a second order low pass filter (LPF) to prevent aliasing of the high frequency noise signal. A second order filter with a 4 kHz cut off frequency will attenuate the noise at 200 kHz by 70dB.

SMD recommendation

A recommended land pattern for LCC20 is shown below. It should be tested and qualified in the manufacturing process. The land pattern and pad sizes have a pitch of 1.27mm and the pin 1 is longer to ensure the right orientation of the product during mounting. After assembly, the orientation can be controlled from the top with an extra point printed on the lid which correspond to pin 1.

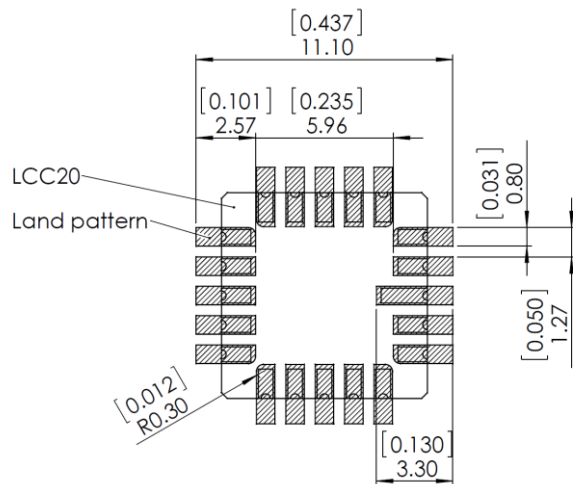

Figure 21 : LCC20 land pattern recommendation (unit are mm/[inch])

The MS1000L is suitable for Sn/Pb and Pb-Free soldering and ROHS compliant. Typical temperature profiles recommended by the solder manufacturer can be used with a maximum ramp-up of 3°C/second and a maximum ramp-down of 6°C/second: The exact profile depends on the used solder paste.

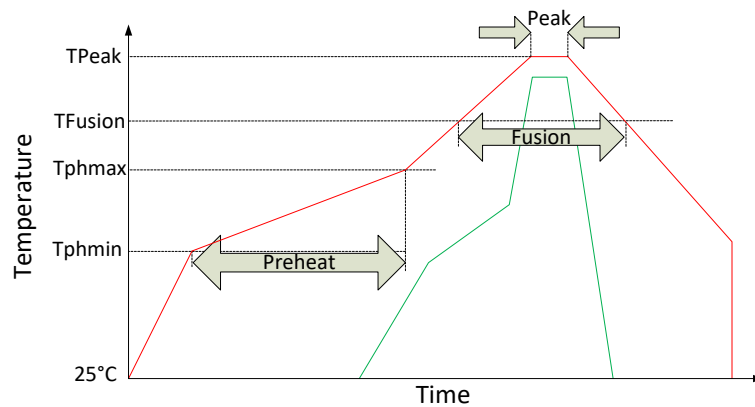

Figure 22: Soldering Temperature Profile

Phase	Sn/Pb		Pb-Free	
	Duration [sec]	Temperature [°C]	Duration [sec]	Temperature [°C]
Peak	10-30	235-240	20-40	245-250
Fusion	60-150	183	60-150	217
Preheat	60-120	Min : 100 Max : 150	60-180	Min : 150 Max : 200

Table 6: Soldering temperatures & times

The cleaning process of electronic boards sometimes involves ultrasounds. This is strongly prohibited on our sensors. Ultrasonic cleaning will have a negative impact on silicon elements which generally causes damages.



Note: Ultrasonic cleaning is forbidden in order to avoid damage of the MEMS accelerometer

Handling and packaging precautions

Handling

The MS1000L is packaged in a hermetic ceramic housing to protect the sensor from the ambient environment. However, poor handling of the product can induce damage to the hermetic seal (Glass frit) or to the ceramic package made of brittle material (alumina). It can also induce internal damage to the MEMS accelerometer that may not be visible and cause electrical failure or reliability issues. Handle the component with caution: shocks, such as dropping the accelerometer on hard surface, may damage the product.



It is strongly recommended to use vacuum pens to manipulate the accelerometers

The component is susceptible to damage due to electrostatic discharge (ESD). Therefore, suitable precautions shall be employed during all phases of manufacturing, testing, packaging, shipment and handling. Accelerometer will be supplied in antistatic bag with ESD warning label and they should be left in this packaging until use. The following guidelines are recommended:

- Always manipulate the devices in an ESD-controlled environment
- Always store the devices in a shielded environment that protects against ESD damage (at minimum an ESD-safe tray and an antistatic bag)
- Always wear a wrist strap when handling the devices and use ESD-safe gloves



This product can be damaged by electrostatic discharge (ESD). Handle with appropriate precautions.

Packaging

Our devices are placed in trays for shipment and SMD process. They are packed in sealed ESD-inner bag. We strongly advice to maintain our device in its original OEM sealed ESD inner-bag to guarantee storage condition before soldering them.

Product identification markings

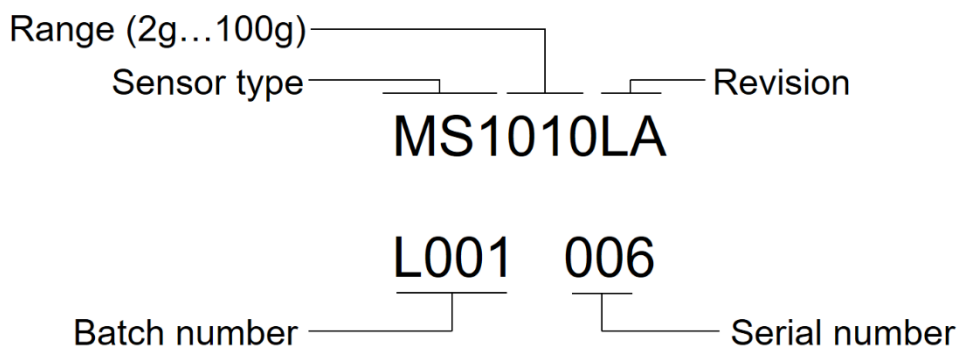

Ordering Information

Description	Product	Measurement range
Single analog axis MEMS accelerometer, 	MS1002LA*	±2g
	MS1005LA*	±5g
	MS1010LA	±10g
	MS1030LA	±30g
	MS1050LA*	±50g
	MS1100LA*	±100g

*Available Q1 2022

Glossary of parameters of the Data Sheet

Accelerometer model

$$\frac{OUT_P - OUT_N}{V_{DD}} * 3.3 = K_1(K_0 + A_s + K_2 \cdot A_s^2 + K_3 \cdot A_s^3 + K_p \cdot A_p + K_h * A_h + K_{sp} * A_s A_p + K_{sh} * A_s A_h + E)$$

A_s, A_p, A_h are the accelerations for each axes of the sensor with:

Input Axis (IA): Sensitive axis

Pendulous Axis (PA): Aligned with the proof mass beam and perpendicular to the input axis

Hinge Axis (HA): Perpendicular to the input and pendulous axes. Direction of the dot.

K_1 is accelerometer scale factor [V/g]

K_0 is bias [g]

K_2 is second order non-linearity [g/g²]

K_3 is third order non-linearity [g/g³]

K_p is pendulous cross-axis [rad]

K_h is output cross-axis [rad]

K_{sp}, K_{io} are cross-coupling coefficients [rad/g]

E is the residual noise [g]

g [m/s²]

Unit of acceleration, equal to standard value of the earth gravity (Accelerometer specifications and data supplied by Safran Sensing Technologies Switzerland use 9.80665 m/s²).

Bias [mg]

The accelerometer output at zero g.

Bias temperature coefficient [mg/°C]

Variation of the bias under external temperature variation (slope of the best fit straight line through the curve of bias vs. temperature). Bias temperature coefficient is the worst of slope at low [-40°C; +20°C] and high [+20°C; +85°C] temperature.

Scale factor [mV/g]

The ratio of the change in output (in volts) to a unit change of the input (in units of acceleration); thus given in mV/g.

Scale factor temperature coefficient [ppm/°C]

Maximum deviation of the scale factor under variable external temperature conditions.

Non-linearity, IEEE [% FS]

Absolute maximum error versus full-scale acceleration

$$NL_{max} \equiv \left| \frac{V - K_1(K_0 + A_s)}{K_1 A_{FS}} \right|_{max} = \left| \frac{K_2 A_s^2 + K_3 A_s^3 + \dots}{A_{FS}} \right|_{max}$$

Frequency response [Hz]

Frequency range from DC to the specified value where the variation in the frequency response amplitude is less than ±3 dB

Noise [µg/√Hz]

Undesired perturbations in the accelerometer output signal, which are generally uncorrelated with desired or anticipated input accelerations.

TurnOn – TurnOn

The accelerometer TurnOn TurnOn bias error is defined as the maximum bias error, when the accelerometer is turned on under defined operational conditions (3.3V supply voltage and ambient temperature).

Long term repeatability (Bias [mg] & Scale factor [ppm])

Evolution of the Bias and Scale Factor values (K0 and K1) measured at sensor level mounted on sockets at 20°C after applying following tests :

- 100 x TurnOn / TurnOn
- Low temperature storage (72h / -55°C), unpowered
- High temperature operating (10days / +85°C), powered
- 10 x temperature cycling [-40°C ; +125°C] unpowered
- 10 x temperature harass [-55°C ; +85°C] unpowered
- Vibration (20grms / 10-2'000Hz)
- Single shock (1000 or 6000g, half sine, 0.15 ms) in one direction, unpowered

Quality

Safran Sensing Technologies Switzerland is ISO 9001:2015, ISO 14001:2015 and ISO 45001:2018 certified

Safran Sensing Technologies Switzerland complies with the European Community Regulation on chemicals and their safe use (EC 1907/2006) REACH

MS1000L products comply with the EU-RoHS directive 2011/65/EC (Restrictions on hazardous substances) regulations

Recycling : please use appropriate recycling process for electrical and electronic components (DEEE)

MS1000L products are compliant with the Swiss LSPro : 930.11 dedicated to the security of products

Note:

- *MS1000L accelerometers are available for sales to professional only*
- *Les accéléromètres MS1000L ne sont disponibles à la vente que pour des clients professionnels*
- *Die Produkte der Serie MS1000L sind nur im Vertrieb für kommerzielle Kunden verfügbar*
- *Gli accelerometri MS1000L sono disponibili alla vendita soltanto per clienti professionisti*

Safran Sensing Technologies Switzerland complies with due diligence requirements of the Conflict Minerals Regulation



Disclaimer

Safran Sensing Technologies Switzerland reserves the right to make changes to products without any further notice.

Performance may vary from the specifications provided in Safran Sensing Technologies Switzerland' datasheet due to different applications and integration. Operating performance, including long term repeatability, must be validated for each customer application by customer's technical experts. The long term repeatability specification expressed in the datasheet is valid only in the defined environmental conditions (cf glossary), and the performance at system level remains the customer's responsibility.

The degolding process applied to the products is excluded from Safran Sensing Technologies Switzerland recommendations. And if applied, cancels any products warranty and liability.

USE OF THE PRODUCT IN ENVIRONMENTS EXCEEDING THE ENVIRONMENTAL SPECIFICATIONS SET FORTH IN THE DATASHEET WILL VOID ANY WARRANTY. SAFRAN SENSING TECHNOLOGIES SWITZERLAND HEREBY EXPRESSLY DISCLAIMS ALL LIABILITY RELATED TO USE OF THE PRODUCT IN ENVIRONMENTS EXCEEDING THE ENVIRONMENTAL SPECIFICATIONS SET FORTH IN THE DATASHEET.

**POWERED
BY TRUST**

Safran Sensing Technology Switzerland

sales@colibrys.com